

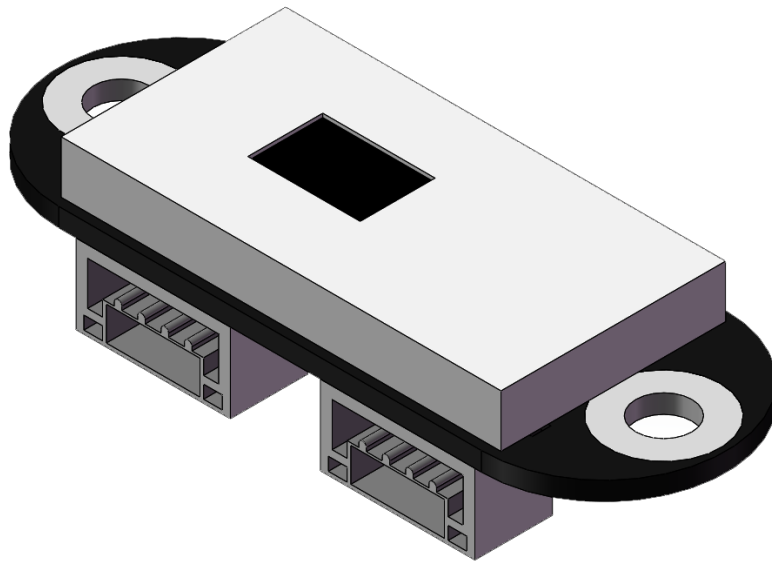

# TOFSense Datasheet V2.0



---

**Language:** English

**Firmware:** V2.0.0

**NLink:** V1.2

**Product Series:** TOFSense

## Contents

Content .....	2
Disclaimer .....	3
1 Introduction .....	4
1.1 Product Overview .....	4
1.2 Product Interface.....	5
1.3 Technology Overview .....	5
1.4 Functional Overview .....	5
2 Typical Specifications .....	6
3 Functional Description .....	7
3.1 ID.....	7
3.2 Interface & Baudrate.....	7
3.2.1 UART .....	7
3.2.2 CAN.....	7
3.3 I/O Output Mode .....	7
3.4 Distance Status .....	7
3.5 Signal Strength .....	8
3.6 FOV .....	8
3.7 Indicator Light .....	8
3.8 Function Key .....	8
4 Typical Performance .....	8
4.1 Test Condition .....	8
4.2 Result.....	9
5 Protocol .....	10
5.1 Composition .....	10
5.2 Endian.....	11
5.3 Type.....	11
5.4 Description .....	11
6 Firmware .....	11
7 Software.....	11
8 Mechanical Specifications.....	12
8.1 Size .....	12
8.2 Figure.....	12
9 Abbreviation and Acronyms.....	12
10 Update Log .....	13
11 Further Information .....	13

## Disclaimer

### Document Information

Nooploop reserves the right to change product specifications without notice. As far as possible changes to functionality and specifications will be issued in product specific errata sheets or in new versions of this document. Customers are advised to check with Nooploop for the most recent updates on this product.

### Life Support Policy

Nooploop products are not authorized for use in safety-critical applications (such as life support) where a failure of the Nooploop product would cause severe personal injury or death. Nooploop customers using or selling Nooploop products in such a manner do so entirely at their own risk and agree to fully indemnify Nooploop and its representatives against any damages arising out of the use of Nooploop products in such safety-critical applications.

### Regulatory Approvals

The TOFSense, as supplied from Nooploop, has not been certified for use in any particular geographic region by the appropriate regulatory body governing radio emissions in that region although it is capable of such certification depending on the region and the manner in which it is used. All products developed by the user incorporating the TOFSense must be approved by the relevant authority governing radio emissions in any given jurisdiction prior to the marketing or sale of such products in that jurisdiction and user bears all responsibility for obtaining such approval as needed from the appropriate authorities.

# 1 Introduction

## 1.1 Product Overview

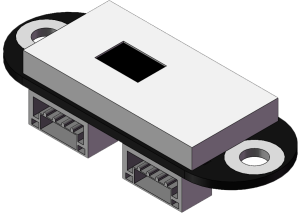
<b>TOFSense Datasheet</b>	
<p><b>Overview</b></p> <p>TOFSense is one laser ranging sensor based on TOF (time of flight). The measuring scope is 1cm~5m, and the range resolution is 1mm; The data update frequency is 10Hz; Adjustable FOV with the maximum field angle is 27°; Supports UART and CAN communication; Support the active and query output data; Support the multi-sensor cascade ranging; Support I/O complementary output;</p>	
<p><b>Key Features</b></p> <ul style="list-style-type: none"> <li>● Based on TOF (Time of Flight) laser ranging technology</li> <li>● Measuring scope 1cm~5m</li> <li>● Range resolution 1mm</li> <li>● Typical ranging precision <math>\pm 1.5\text{cm}</math></li> <li>● Adjustable field angle (FOV), 15~27°</li> <li>● Support UART, CAN, I/O communication</li> <li>● UART, CAN, I/O shared interface</li> <li>● Support multi-module cascade</li> <li>● Active and query output</li> <li>● One-click upgrade firmware</li> <li>● 3.7~5.2V powers supply with anti-reverse protection</li> <li>● Power consumption is about 290mW</li> <li>● 940nm laser in compliance with Class1 Standard stipulated in IEC 60825-1:2014Version 3</li> </ul>	<p><b>Applications</b></p> <ul style="list-style-type: none"> <li>● Unmanned aerial vehicle height setting, ceiling detection</li> <li>● Robot obstacle avoidance</li> <li>● Measuring and detecting</li> <li>● Intelligent gesture control</li> <li>● 1-dimension gesture identification</li> </ul>

## 1.2 Product Interface

Line sequence of UART interface is written as “V G R T” for short with correspondence to VCC, GND, RX, TX;

Line sequence of CAN interface is written as “V G H L” for short with correspondence to VCC, GND, CAN\_H, CAN\_L;

Line sequence of I/O output interface is written as “V G H L” for short with correspondence to VCC, GND, I/O\_H, I/O\_L.

In which, VCC is power supply, GND is power ground.

Note: Figure 1 doesn't represent the actual dimension, and the actual dimension shall refer to Chapter 8.

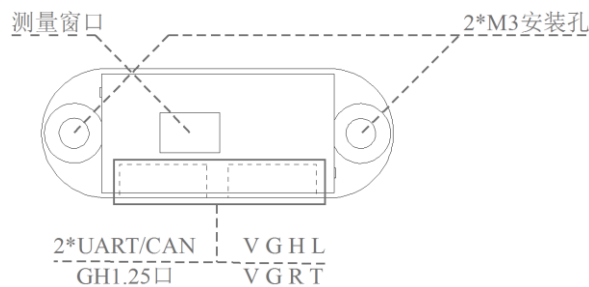

Figure 1: TOFSense Interface

## 1.3 Technology Overview

TOF is one absolute distance detecting technology, that is the sensor emits the near-infrared light to be debugged, and it will reflect after encountering the object. The sensor calculates the distance of subject being photographed through calculating the time difference or phase difference for the emission and reflection of light so as to produce the depth information. Compared with the binocular plan and 3D structural light plan, TOF has the advantages of long working distance, wide application scenarios and high precision of long distance etc. Therefore, it is always applied to the personnel proximity detection, robot obstacle avoidance, camera automatic focusing etc. The near-infrared light coming from the sun light in the out-door environment will generate the impact to the measuring effect of module.

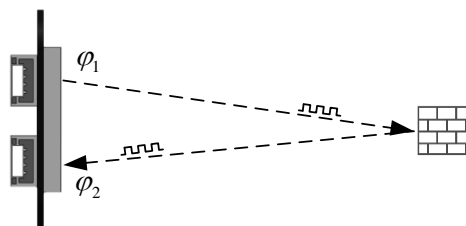

Figure 2: Schematic Diagram of TOF Ranging Principle

## 1.4 Functional Overview

TOFSense supports three distance measuring modes including short, medium and long, supports several FOV angle setups, which can meet the demands of several scenes. It can output the information e.g. distance measuring value, distance status and signal strength etc.;

Output mode: TOFSense supports the active output and query output. The active output is that the module independently connects and send the measuring data frame, and sends the frequency 10Hz; The query output is that after the module outputs the measuring data frame after receiving the query frame.

Connection mode: TOFSense supports UART and CAN output modes, and these two output modes share one set of physical interface. In which, UART output supports the active output and query output of single module, as well as the query output under several cascade connection; CAN output supports the active output and query output of single module, as well as the active output and query output under the cascade connection of multiple modules.

## 2 Typical Specifications

Table 1: Typical Specification

Parameters	Typical	Note
Product Weight: g	2.7	*
Dimension: mm	35.58*12*8.05	Length*Width*Height. Detailed dimension shall refer to Chapter 8
Communication Interface	UART	Two interfaces can be simultaneously as UART interface, electrical level of TTL signal line is 3.3V. Baudrate is 921600 in default.
	CAN	Two interfaces can be simultaneously as CAN interface; Baud rate is 1Mbps in default.
Cascade Quantity	UART: 8	Maximum quantity of supporting cascade upon the test.
	CAN: 7	
Typical Ranging Scope: m	Short distance: 0.012~2.16	Data is obtained based on the test in Chapter 4.
	Medium distance: 0.012~3.60	
	Long distance: 0.01~5.00	
Typical Ranging Precision	Short distance: Precision $\pm 1.0\text{cm}$ , Standard deviation $< 0.3\text{cm}$	Data is obtained based on the test in Chapter 4.
	Medium distance: Precision $\pm 1.0\text{cm}$ , Standard deviation $< 1.5\text{cm}$	
	Long distance: Precision $\pm 1.5\text{cm}$ , Standard deviation $< 0.5\text{cm}$ @[0.01,3]m scope, Standard deviation $< 8\text{cm}$ @[3,5]m scope	
Wave Length: nm	940	Comply with Class 1 Standard in IEC 60825-1:2014 Version 3.
Field Angle (FOV): $^{\circ}$	15~ 27	Gear resolution is $1^{\circ}$ , support to set up the offset at X and Y directors.
Voltage of Power Supply: V	[3.7,5.2]	Power supply of all communication interfaces have the electric connection, and power supply interface can be any interface.
Power Consumption: mW	290	Under UART active output and long distance measuring mode, voltage of power supply is

		5.0V and current is 58mA.
Working Temperature: °C	[-20,85]	Measuring data is obtained by rough measurement under the actual environment, and the actual usage shall be subject to the working environment.

### 3 Functional Description

#### 3.1 ID

ID is one variable set up for distinguishing the different sensors, which is used to identify each sensor during the cascade connection.

#### 3.2 Interface & Baud Rate

TOFSense supports two communication modes with configurations are UART and CAN.

##### 3.2.1 UART

Under the serial port communication, the setting range of Baud rate shall be shown as Table 2: UART Baud Rate Parameter List

Table 2: UART Baud Rate Parameter List

UART Baud Rate	Note
115200,230400,460800,921600,1000000,1200000,1500000,2000000,3000000	Baud Rate is 921600 in default

##### 3.2.2 CAN

Under CAN output mode, the setting range of Baud rate shall be shown as Table 3.

Table 3: CAN Baud Rate Parameter List

CAN Baud Rate	Note
100K, 250K, 500K, 1M, 2M, 3M	Baud rate is 1M in default

#### 3.3 I/O Output Mode

Under this mode, the module can output two complementary high and low electric levels according to the distance hysteresis range change.

#### 3.4 Distance Status

The module can output the current distance status, the user can perform the data processing with the combination of distance status. The meaning of distance status is shown as Table 4.

Table 4: Meaning of Distance Status

Value	Note
0	Measuring distance is valid
1	Standard deviation is more than 15mm
2	Signal strength is lower than 1Mcps

4	Phase exceeds boundary
5	HW or VCSEL has fault
7	Phase is not matched
8	Internal algorithm underflow
14	Measuring distance is invalid

### 3.5 Signal Strength

Indicate the strength of current return signal, and the larger this value indicates the stronger the return signal.

### 3.6 FOV

The field angle FOV determines the vision scope of TOFSense. The module can change the field angle at X direction fov.x, field angle at Y direction fov.y, offset at X direction fov.x\_offset and offset at Y direction fov.y\_offset. The setting scope for field angle at X, Y directions is  $15^{\circ} \sim 27^{\circ}$ . The setting scope of offset for field angle at X, Y directions is  $-6^{\circ} \sim 6^{\circ}$ .

### 3.7 Indicator Light

The indicator includes two flashing status in total, including the fast flash once per 0.1S and slow flash once per 1S. LED status and meaning are shown as Table 5.

Table 5: Meaning of Indicator Light

Status	Note
Fast Flash (interval 0.1S)	Module starting stage
	Module firmware update
Slow Flash (interval 1S)	Module normal working

### 3.8 Function Key

It is used for the parameter setup under CAN communication mode. Press the power-on key until the indicator has the slow flash, and then compulsively enters UART configuration mode. This operation will not change the module setting parameter. If changing the module setup, it is required to rewrite the parameter.

## 4 Typical Performance

### 4.1 Test Condition

Table 6: Testing Parameter Configuration

Name	Content	Note
Hardware	TOFSense	*
Temperature: °C	[10,40]	*
Venue	Nooploop No. 2 Experiment Base (Shenzhen)	*
Time	201908	*



Environment	Open ground outdoors	*
Working Mode	UART active output	*
FOV: °	27	*
Voltage of Power Supply: V	5	*
Refresh Rate: Hz	10	*

Under this configuration, the node outputs the measuring data periodically, take samples for measurement with interval of 60cm, and the measuring time is 1min each time. Through NAssitant, it performs the data recording output,

Define the error:

$$\text{error} = \text{measure\_value} - \text{real\_value}$$

Where, measure\_value ---Measuring distance

real\_value ---Actual distance

Define the standard deviation std:

$$\text{std} = \sqrt{\frac{1}{N-1} \sum_{i=1}^N |A_i - \mu|^2}$$

Where, N ---Quantity of samples

A ---Random variable composed by N sampling values

$$\mu = \frac{1}{N} \sum_{i=1}^N A_i$$

## 4. 2 Result

Process the measuring data based on the above conditions, the final results are shown as Figure 3, Figure 4 and Figure 5.

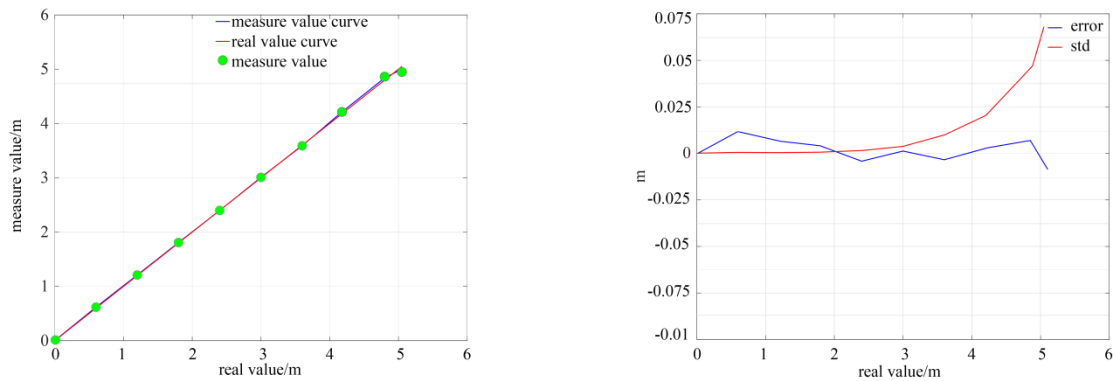

a.Measuring Value and Real Value Curve

b.Error and Standard Deviation Curve

Figure 3: Testing Result of Long Distance Mode

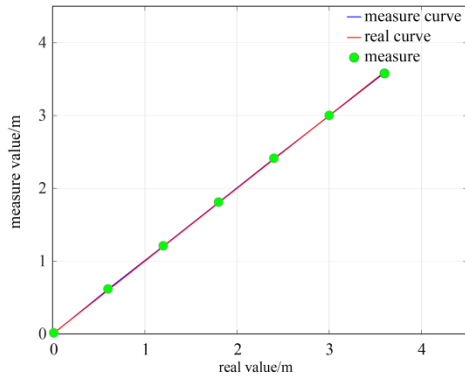

a.Measuring Value and Real Value Curve

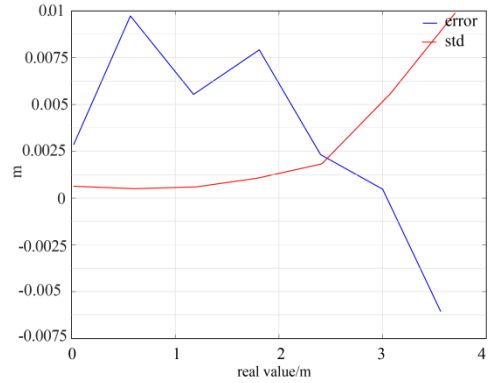

b.Error and Standard Deviation Curve

Figure 4: Testing Result of Medium Distance Mode

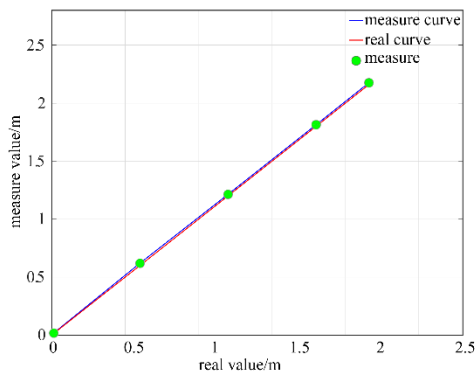

a.Measuring Value and Real Value Curve

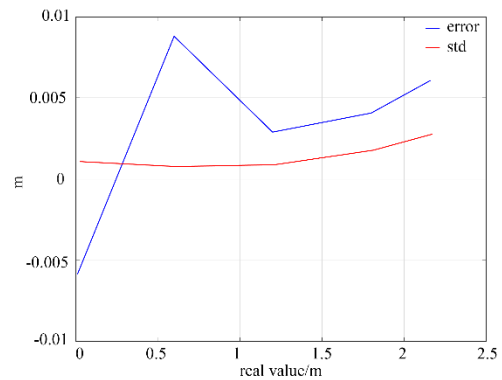

b.Error and Standard Deviation Curve

Figure 5: Testing Result of Short Distance Mode

Calculate according to the experimental results, as shown in Table 7.

Table 7: Precision Parameter of TOFSense

Range Mode	Bind Zone (cm)	Maximum Distance (m)	Precision (cm)	Standard Deviation (cm)
Short	1.2	2.16	$\pm 1.0$	<0.3
Medium	1.2	3.60	$\pm 1.0$	<1.5
Long	1.0	5.05	$\pm 1.5$	<0.5 @[0.01,3]m
				<8 @(3,5]m

## 5 Protocol

TOFSense data communication format follows NLink protocol, please refer to NLink file.

### 5.1 Composition

As shown in Table 8, Protocol is composed of Frame Header, Function Mark, Data, Sum Check. In which, the Frame Header, Function Mark are the fixed values; Data is the data content to be transmitted, Sum Check is the lowest byte after summing up Frame Header, Function Mark, Data (that is to sum up all bytes).

Table 8: Composition of Protocol

Frame Header	+	Function Mark	+	Data	+	Sum Check
--------------	---	---------------	---	------	---	-----------

## 5.2 Endian

NLink follows Little-endian principle, that is the low byte is at the front and high byte is at the back.

## 5.3 Type

**Fixed length protocol:** Protocol for length fixture;

**Variable length protocol:** Protocol for length variation;

NLink protocol is composed of the fixed length protocol and variable length protocol, which can meet the demands of different scenes.

## 5.4 Description

Table 9: NLink Protocol Content Description

Protocol	Type	Description
NLINK_TOFSENSE_FRAME0	Fixed length	UART output protocol, the content includes node timestamp, distance, distance status, signal strength
NLINK_TOFSENSE_READ_FRAME0	Fixed length	UART reads protocol, the content includes Node ID
NLINK_TOFSENSE_CAN_FRAME0	Fixed length	CAN output protocol, the content includes distance, distance status, signal strength
NLINK_TOFSENSE_CAN_READ_FRAME0	Fixed length	CAN reads protocol, the content includes Node ID

## 6 Firmware

The version number format for the firmware of official release is VA.B.C, and the version number format for the firmware of testing release is VA.B.C BetaD. Both of them can be checked whether there is any latest firmware through NAssistant and carry out the firmware upgrade, as well as support the wired firmware upgrade.

## 7 Software

NAssistant is the accessory debug software for TOFSense with the main functions are: Debug configuration, Status display, Function application, Firmware upgrade.

**Debug configuration:** Used for configuring the relevant parameters of nodes, e.g. ID, working mode, Baud rate etc.

**Function application:** Used for the application development, e.g. data import and export, motion trail storage, historical trial replay etc.

**Firmware upgrade:** Used for carrying out the wired firmware upgrade for product.

## 8 Mechanical Specifications

### 8.1 Size

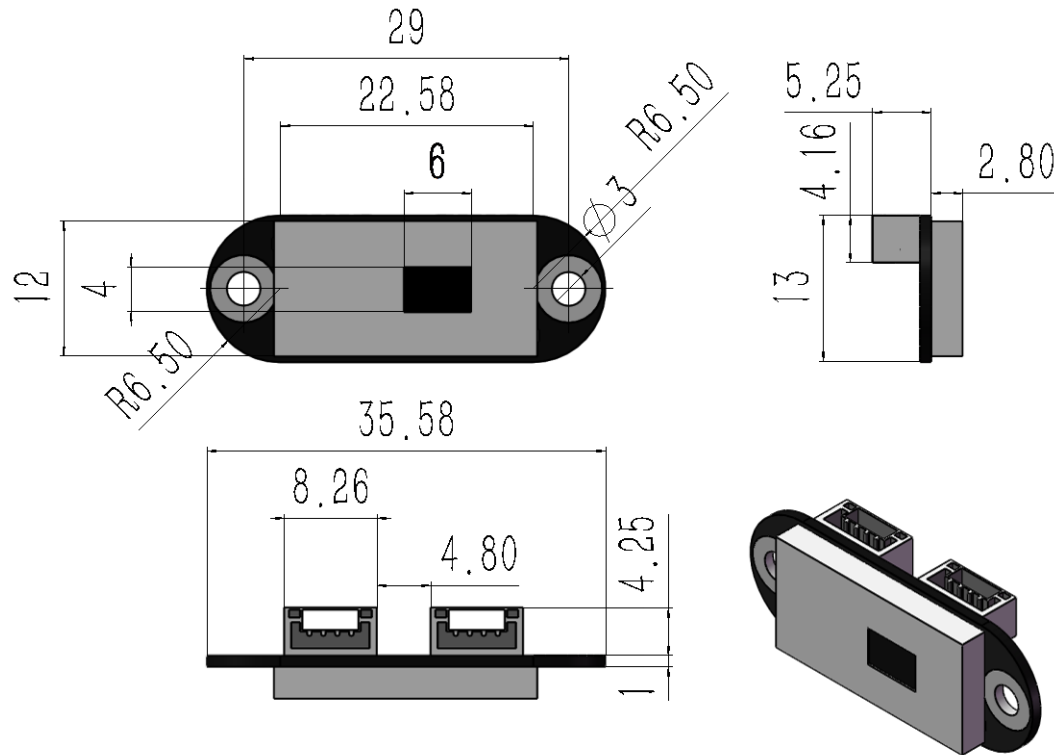

Figure 6: Dimension Diagram of TOFSense, Unit: mm

### 8.2 Figure

Note: The product picture doesn't represent the actual dimension, and the actual dimension shall refer to 8.1.



Figure 7: Picture of TOFSense

## 9 Abbreviation and Acronyms

Table 10: Abbreviation and Acronym

Abbreviation	Full Title
TOF	Time of Flight
FOV	Field of View
HW	Half Wave
VCSEL	Vertical Cavity Surface Emitting Laser

## 10 Update Log

Table 11: Update Log

Version	Firmware Version	Data	Description
1.0	1.0.0	20190817	1. Release first-edition Sheet
1.1	1.0.4	20190923	1. Update FOV parameter description 2. Adapt the latest firmware version
1.2	1.0.6	20191213	1. Modify the error in Sheet. 2. Adapt the latest firmware version.
2.0	2.0.0	20200730	1. Add I/O output mode description. 2. Adapt the latest firmware version.

## 11 Further Information

**Company:** Shenzhen Nooploop Technology Co., Ltd.

**Address:** A2-207, Peihong Building, No. 1, Kehui Road, Technology Park Community, Yuehai Street, Nanshan District, Shenzhen City

**E-mail:** [marketing@nooploop.com](mailto:marketing@nooploop.com)

**Website:** [www.nooploop.com](http://www.nooploop.com)